



DALI KORE

STATE-OF-THE-ART LOUDSPEAKER TECHNOLOGY

WHITE PAPER

VERSION 1 - 19 MAY 2022

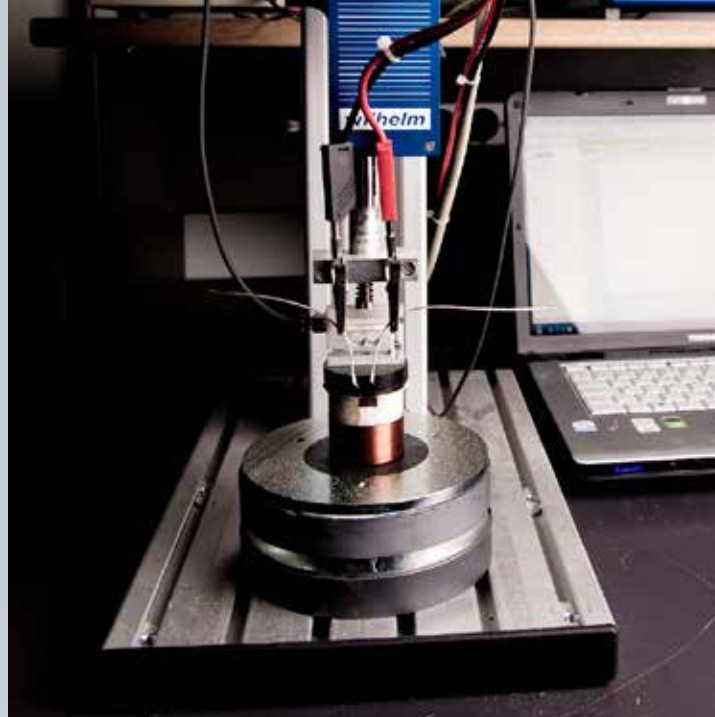

“ The DALI KORE represents for DALI a design, electro-acoustic, engineering, manufacturing and musical rebirth.”

LARS WORRE
DALI CHIEF EXECUTIVE OFFICER



Introduction

At DALI, we have a passion for music. For four decades we have created loudspeakers built on our own past achievements. Step by step, we've evolved our products to enrich the lives of our customers through a love of music, and excellence in audio reproduction. And now we're taking the next step in that narrative, investing everything we know in the finest speaker we are able to make: the DALI KORE – Because only music matters.

“**The DALI KORE stands on the shoulders of all the DALI speakers that have gone before, and it sees further into the landscape of music as a result.**”

KRESTIAN PEDERSEN
DALI HEAD OF PRODUCT MANAGEMENT

In this white paper, we tell the story of the DALI KORE, from its very first origins to the finished product. We describe its history, context, philosophy, creation, engineering and production. The DALI KORE story is naturally one of industrial design, electro-acoustics and multidisciplinary manufacturing, but it's also a story of striving to reach hugely ambitious goals and overcoming seemingly insurmountable challenges – because the path to perfection (or as close to it as we can achieve) never runs smoothly. For our company, the DALI KORE story is also one of growth, learning and becoming more ambitious with advanced technologies and manufacturing.



DALI KORE

Context and Landscape

The DALI KORE was not designed in a vacuum. Its physical form and performance was inevitably influenced by the context of its development and the landscape in which it will thrive.

Music Explosion

We're living through a golden age of creativity in music and opportunities for its enjoyment at home. The ubiquity of streaming services enables audiophiles to discover and enjoy an almost limitless supply of new and fascinating artists, while the arrival of very high resolution digital audio formats has awoken new interest in sound quality. The near simultaneous resurgence of vinyl has also rekindled the intense pleasure and enjoyment that owning records brings to music lovers. Yet, though the remarkable capabilities of contemporary Hi-Fi equipment enable previously unimaginable levels of electro-acoustic performance, the full dynamics of a symphony orchestra, for example, is still all too often out of reach. With the DALI KORE, this is no longer the case.

Flourishing Artistry

Musical artistry is also flourishing. Musicians across every genre and level of ambition have access to tools and technology that bring the opportunity for composition and creative exposure into the everyday. The result is an explosion of musical creativity that delivers to audiophiles an almost unlimited variety of new music. For DALI, the time is right to express itself with a flagship product that reflects this golden age of creative artistry.

Made in Denmark

With the DALI KORE, we also aspired to expand our in-house manufacturing capabilities and to utilise Danish businesses by sourcing more components locally. The DALI KORE enclosure, for example, incorporates elements made from die-cast aluminium, structural composites and even a cement based resin composite, all of which are sourced from suppliers located within easy reach of our production facilities in central Denmark. We also invested in a long established and renowned local specialist manufacturer of curved wood panels for the Danish furniture sector; a technique that we later used to create the elegant, curved lines of the DALI KORE.

“ With local suppliers, quality is better, delivery is more reliable and communication is easier.”

THOMAS MARTIN HOLM
DALI CHIEF OPERATING OFFICER

Investing in the Future

As well as investing in Denmark, it was important for us to further develop our in-house capabilities. To create the curved carcass of the DALI KORE enclosure, for example, we invested in a new five-axis, computer-controlled machining facility. And to deliver on the high expectations we had for the DALI KORE finish quality, we invested in a new robot-equipped painting and lacquering facility. With investments like these, not only are we guaranteeing the quality of the DALI KORE, but we are able to incorporate new design thinking into our future product ranges.

DALI Electro-Acoustics



DALI has always been driven to explore electro-acoustic technologies and create innovative products that push the boundaries of what's possible. Designs such as the DALI MegaLine of the mid 1990s, DaCapo of 1988 and SKYLINE of 1992 explored line-source, wide-range ribbon driver and open baffle technologies. Even apparently more conventional designs, such as the DALI 40 SE of 1987 and the EUPHONIA series of 2002, incorporated significant innovations like complex coupled-cavity bass loading and the very first hybrid dome and ribbon tweeter. While the electro-acoustic configuration of the DALI KORE may be a 'clean slate' design, the experience and know-how we've gained from decades of producing acclaimed loudspeakers has been fundamental in its development.

“ The DALI KORE explores new territory, but it's a continuation of a journey that we've been on since our very first loudspeaker.”

KRESTIAN PEDERSEN
DALI HEAD OF PRODUCT MANAGEMENT

“ The heart of the DALI KORE is in its detail. It's more than the sum of its parts, not least because those parts are, in so many cases, extraordinary.”

THOMAS MARTIN HOLM
DALI CHIEF OPERATING OFFICER

The electro-acoustic design philosophies of the DALI KORE follow the same DALI Sound Philosophies that drive every speaker to carry the DALI logo:

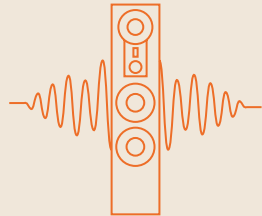

Low Loss

Minimising loss in a speaker system means ensuring all the fine detail of music is delivered to the listener. In electro-acoustic engineering terms, that means selecting materials that offer minimal non-linear electro-mechanical damping, and minimising un-musical and fatiguing odd-order distortions. One of the most striking elements of the DALI KORE are the lengths we've gone to in the magnet and voice-coil heart of the bass and midrange drivers to engineer such phenomena down to levels long thought unattainable in conventional moving-coil speakers.

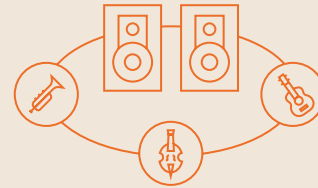

Holographic Sound Imaging

Creating a believable soundstage is all about reproducing all elements of the audio signal at exactly the right time and at exactly the right level. To do this, it's crucial to minimise electro-mechanical distortion, power compression, cabinet diffraction and signal loss in the drivers and crossover. The goal is to make the speaker disappear and reproduce the sound exactly as the artist intended.

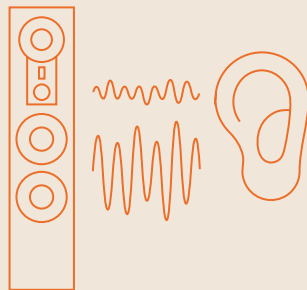

Time Coherence

Ensuring perfect timing across the drivers and an optimised handover from one driver to the next is the basis for a believable audio experience. The DALI KORE drivers are time aligned in terms of both their physical positions in space and their acoustic relationship to each other via the crossover filters.

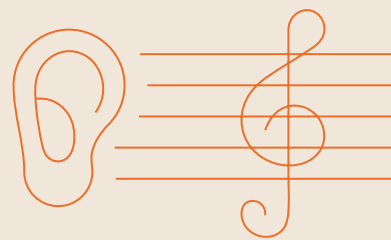

Clarity

Clarity in audio reproduction results from minimal signal loss, distortion and power compression combined with seamless and linear, full-bandwidth performance in both time and frequency domains. The DALI KORE extends this principle across a wider bandwidth than any DALI speaker before.

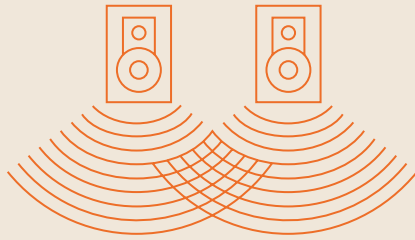

Wide Dispersion

Optimising a speaker's off-axis performance means that direct and reflected audio signals reaching the ears have a similar tonal character. The result in the DALI KORE is consistently exceptional imaging in almost any listening room, as the ear isn't distracted by spurious uncorrelated reflections.

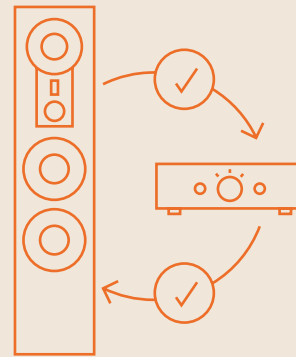

Amplifier Optimised

Providing a stable, linear speaker impedance to an amplifier is critical for it to deliver the best possible audio performance. The DALI KORE impedance characteristic sits right in the sweet spot for the majority of high performance amplifiers, enabling them to deliver the music with nothing added and nothing taken away.

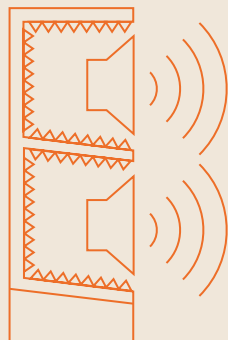

Low Resonance Cabinet

Loudspeaker cabinet surface area is typically far larger than the surface area of the drivers, so minimising cabinet vibration is essential for accurate and natural sound reproduction. The sophisticated DALI KORE cabinet construction ensures a completely inert and non-resonant foundation on which the drivers can perform.

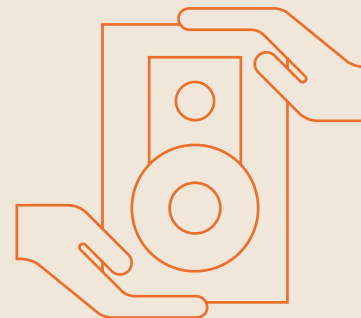

Individually Crafted

We apply the best of industrial manufacturing and individual craftsmanship to create high quality speakers that are worthy of the DALI logo. For the DALI KORE, it's no different.

DALI KORE

Industrial Design, Engineering and Manufacturing

DALI has always embraced the principles of holistic industrial design. How a speaker looks and feels, the values it communicates through its materials, and the way it integrates into the home are arguably as important as how it sounds. We don't just make speakers; we manufacture products that are optimised to meet the long-term needs of our customers, where every component is specifically engineered to play its role. The DALI KORE is no different. It's a very large speaker – it has to be – but that doesn't mean it can't be used in ordinary homes or be as beautiful to look at and touch as it is to listen to.

“ It's important that in communicating the beauty of music, the DALI KORE is also a beautiful object.”

MADS ULLITS
DALI DESIGN MANAGER

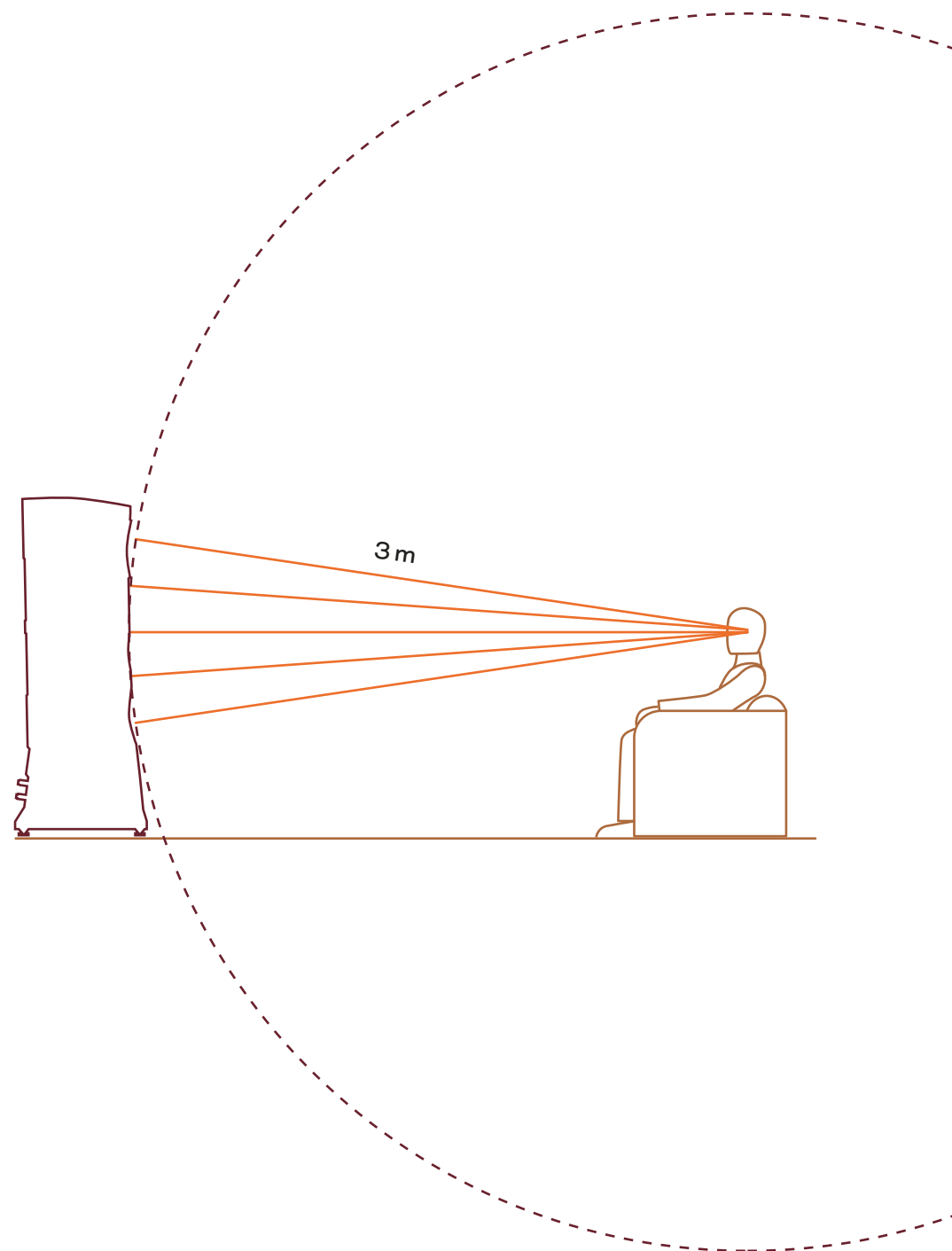

The EMINENT ME9

The roots of the industrial design concept for the DALI KORE reach back over a decade. In 2008, we conceived the EMINENT ME9 high-end speaker, followed in 2011 by a working prototype. However, the worldwide financial turbulence of the time resulted in its cancellation. The EMINENT ME9 aesthetic was, however, very well received, and although a variety of other options were considered for the DALI KORE, the industrial design of the EMINENT ME9 became an important reference point.

Aesthetic and Electro-Acoustic Considerations

Deciding on the physical form of a high-end Hi-Fi speaker is a balance between the visual aesthetic and the electro-acoustic considerations. For example, one of the acoustic design aims of the DALI KORE was to ensure that the output of each driver would arrive at the listening position – three metres from the speaker – perfectly in sync. Such considerations of timing are one of our core electro-acoustic philosophies. The adjacent diagram illustrates how this resulted in the curved form of the DALI KORE front panel. Similarly, to reach our low frequency bandwidth sensitivity and maximum volume level targets, the DALI KORE required two 11½ inch woofers in a total low frequency enclosure volume of 144 litres.

So just those two acoustic constraints predominantly defined the physical scale and architecture of the DALI KORE. From that point onward, the industrial design exercise became one of deciding the structural and aesthetic form, mechanical construction and surface finishes.

“One design principle was to locate the drivers on a three metre radius aligned towards the listening position. Then, with the appropriate air volume added behind the midrange and bass drivers, the DALI KORE shape almost drew itself.”

MADS ULLITS
DALI DESIGN MANAGER



▲ The DALI EMINENT ME9 of 2008 helped inspire the industrial design of the DALI KORE.

Design and Build

It's not possible to disconnect the design of a speaker's aesthetic, mechanical construction or surface finishes from either its electro-acoustic performance or its manufacturing feasibility. A large speaker enclosure, for example, has far more panel surface area with the potential to radiate acoustic energy and colour the sound than a small enclosure. So, ensuring that every DALI KORE enclosure panel was acoustically inert became more critical. And a large, expensive speaker implies large components of high inherent value, so handling those components throughout the manufacturing and assembly processes took on extra jeopardy. Ensuring that each part reliably fits together with consistent join lines and hidden fixings is an industrial design function too. That the DALI KORE has no visible fixings didn't happen by chance. It was a design aim; one that required many hours of creative engineering commitment.

The DALI KORE Enclosure

The DALI KORE design incorporates a variety of materials, each chosen for their aesthetic, structural and acoustic properties. The rear shell of the enclosure, for example, is created from a curved 28 mm birch laminate core and a 4 mm wood composite panel – a construction that results in a completely inert structure in terms of panel resonance.

Also unusual is the assembly technique used to attach the curved enclosure shell to the flat, 30 mm thick birch laminate front panel. The front edges of the shell are pulled apart by 20 mm and then released, locking the front panel into position. Within the completed enclosure carcass formed by the rear shell and front panel, multiple birch laminate shelves provide structural bracing and divide the internal volume. The curved shell of the enclosure and angled shelves avoid internal parallel surfaces that could lead to standing wave acoustic resonance. Each DALI KORE bass driver is rear loaded by separate air volumes, each with its own dual-flare reflex port. The internal enclosure structure is also engineered to provide an isolated open-back transmission line for the midrange driver.

The gold-plated bi-wire/bi-amp terminals are in-house designed and manufactured to ensure a completely lossless connection. ✓

The curved birch laminate enclosure shell is manufactured locally in Denmark. ✓

The enclosure shell is finished in a unique Ammara Ebony veneer. ✓

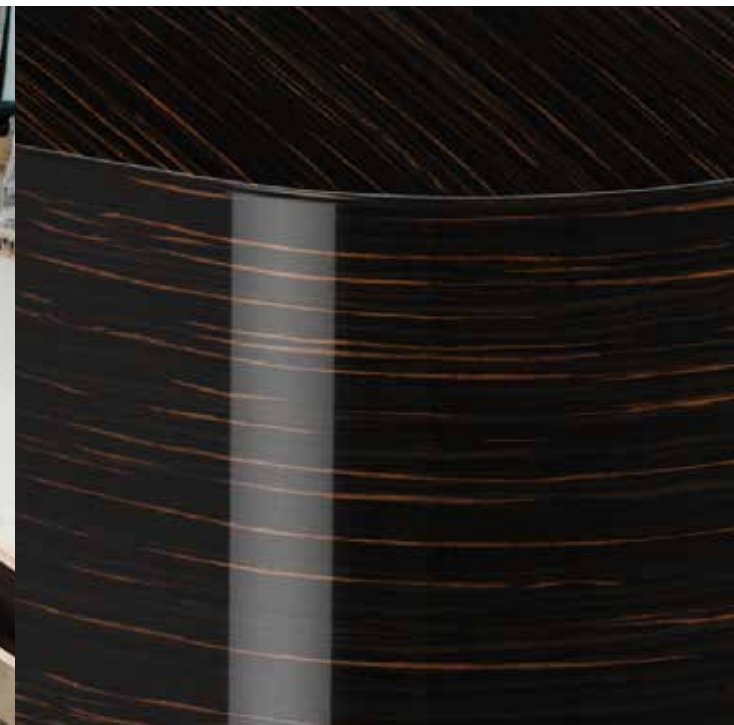

The DALI KORE Plinth & Baseplate

The plinth component of the DALI KORE provides a rigid foundation for the main enclosure and attachment points for the baseplate with its outriggers and conical feet. It also provides isolation from vibration and air pressure changes for the lower crossover components. The plinth is manufactured from a precision-cast resin composite material, which, as well as offering the immense compressive strength necessary to support the DALI KORE's 140 kg weight, can be comparatively easily cast with complex geometry and generously dimensioned wall thicknesses. The rigid plinth housing the large crossover components keeps them well away from the drivers, which avoids potential crosstalk between the woofers and the inductors. The plinth material also offers a beautiful surface finish, both in appearance and to the touch.

The DALI KORE Midrange and Tweeter Baffle

Matching the impressive constructional rigidity and stability of the 34 kg DALI KORE base, the requirement for similar structural qualities led us to the use of die-cast aluminium for the integrated midrange and tweeter baffle assembly.

Compared with a traditional wood panel enclosure, an aluminium die-casting offers much more precision and is inherently light and immensely rigid. With an aluminium die-casting, we were also able to integrate all the necessary boss and hole features needed to attach the drivers and other components.

To create a construction free of any resonance, the DALI KORE features multiple moulded silicon mass dampers attached strategically at anti-node locations to render the casting mechanically inert. The silicon mass dampers are far more effective than traditional bitumen-based damping, which often tends to lower the frequency of a resonance rather than fully suppress it.

The DALI KORE EVO-K hybrid tweeter ribbon element incorporates brand new motor system and waveguide components. **V**



“As well as focusing on the actual design, we focused on selecting manufacturing processes that would fit with our strategy of having more components made locally in Denmark.”

MADS ULLITS
DALI DESIGN MANAGER

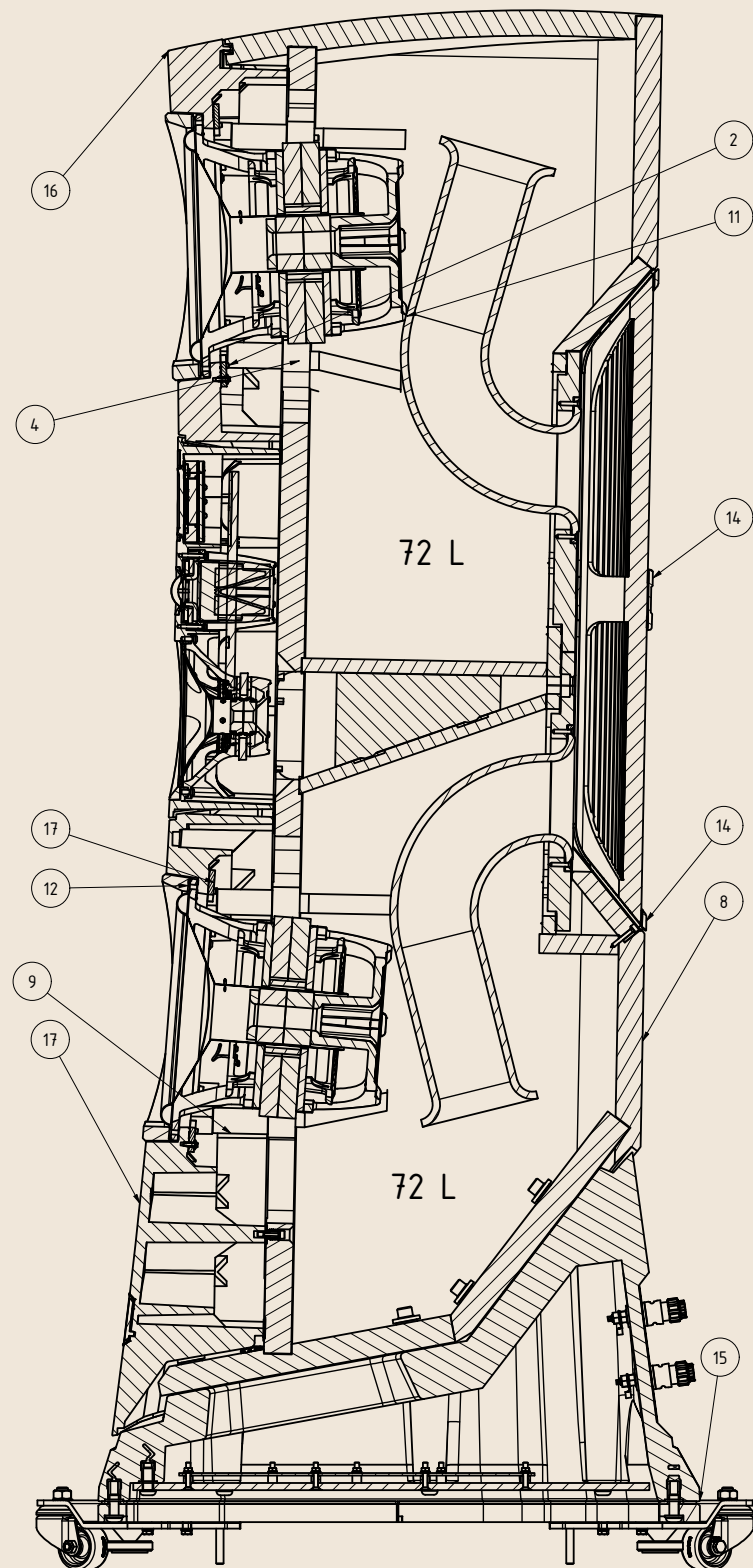

The DALI KORE Bass Driver Housing

The final structural components of the DALI KORE comprise two composite resin cast housings for the twin bass drivers. The material is mineral loaded to provide enhanced mechanical properties and has complex internal structural reinforcement for rigidity. As with the midrange and tweeter die-casting, the bass driver mouldings are bolted to the front panel of the enclosure.

The DALI KORE – Pulling It All Together

Building the DALI KORE requires significant physical effort and the finest of precision control. While the heavy primary components require careful and considered handling, smaller and lighter elements often need even greater care. Even a slightly excessive application of adhesive to a tweeter dome, for example, will render it useless. From locking the front panel into position to soldering the ribbon tweeter lead-out wires, assembling the DALI KORE demands commitment, skill and know-how.

< A section view through the DALI KORE.

DALI KORE

Electro-Acoustic Design

When it came to the development of the DALI KORE, we wanted to be uninhibited by physical size and cost to meet our design goals. But designing a successful Hi-Fi speaker is about finding the right balance of technical specifications and sound characteristics. Focusing on one element will likely leave other elements out of balance, resulting in a speaker that is subjectively unsatisfying. For the DALI KORE, we believe we've struck the perfect balance with a system that comprises:

- Five drivers
- Twin differentially filtered, 11½ inch diameter bass drivers
- A 7 inch diameter midrange driver
- An EVO-K Hybrid Tweeter module comprising a 35 mm diameter soft dome tweeter and a 55 mm x 10 mm ribbon element.

“ Each DALI KORE driver was developed from the ground up and incorporates significant innovations that are not only new to DALI, but are found only rarely throughout the world of electro-acoustic design.”

KIM KRISTIANSEN
DALI CHIEF TECHNOLOGY OFFICER



Balanced Drive SMC

At DALI, our fundamental philosophy throughout four decades of electro-acoustic engineering has been to minimise non-linearity and signal losses at the magnet and voice-coil motor system heart of a driver. This philosophy led to the introduction of our unique SMC (Soft Magnetic Compound) material for the DALI EPICON range in 2012. SMC works by suppressing some of the fundamental distortion and signal loss mechanisms of conventional speaker motor systems. You can read about SMC in more detail in a later section of this white paper.

For the DALI KORE bass and midrange drivers, not only have we developed SMC to new levels of effectiveness, now called Gen-2, we've also implemented a DALI patented technology that reduces motor system non-linearity and signal loss even further – we call this technology Balanced Drive SMC.

Balanced Drive

The Balanced Drive concept of twin voice-coils dates back to the 1970s. But, due to patent protection and the significant engineering difficulties in its manufacture, it has rarely been implemented... until now. The original patent protection has long since lapsed and with the aid of modern computer-aided engineering and manufacturing, we decided to adopt the twin voice-coil architecture for the DALI KORE.

The benefit of the Balanced Drive architecture is that it acts to reduce harmonic distortion and compression at the heart of the electro-acoustic transducer. As a voice-coil moves within its magnetic field, it typically encounters directional nonlinearities caused by mechanical geometry and more subtle electro-dynamic effects. While both can be reduced through careful design, they can never be eliminated. In a Balanced Drive dual voice-coil system, however, as one voice-coil moves inwards through the magnet field, the other voice-coil moves outwards, cancelling out the directional nonlinearities. The result is a very significant reduction in distortion, particularly of the subjectively fatiguing and unmusical odd-order harmonics (3rd, 5th, 7th, etc.).

The Balanced Drive voice-coil topology of the DALI KORE bass drivers also significantly extends linear driver diaphragm displacement and reduces power compression. With a conventional single voice-coil arrangement, as audio volume increases and the voice-coil movement approaches the limit defined by its length and the thickness of the magnet top-plate, distortion will increase. With twin voice-coils, this nonlinearity is cancelled out by the complementary geometry of the pair. As a result, the DALI KORE bass drivers boast an unusually generous ± 15 mm of linear diaphragm displacement. The benefit is reduced odd-order distortion and minimal compression at high volume levels and when reproducing material with extended low frequency content.

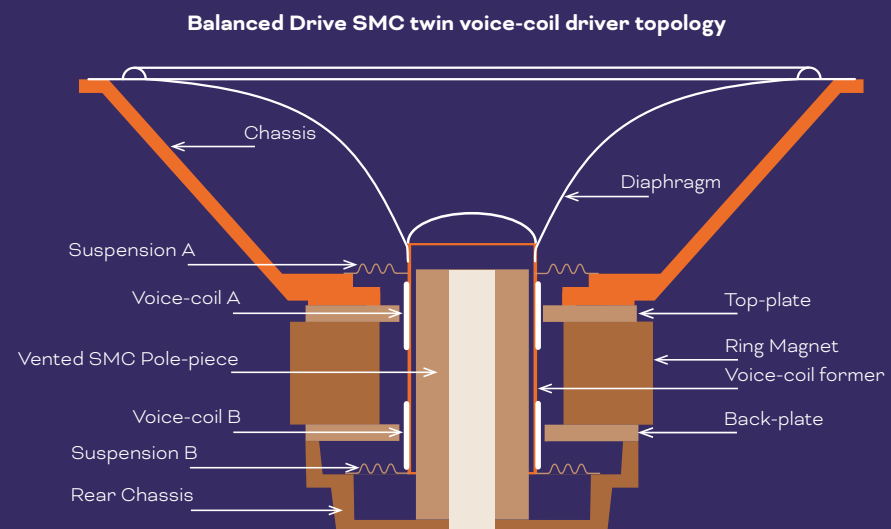
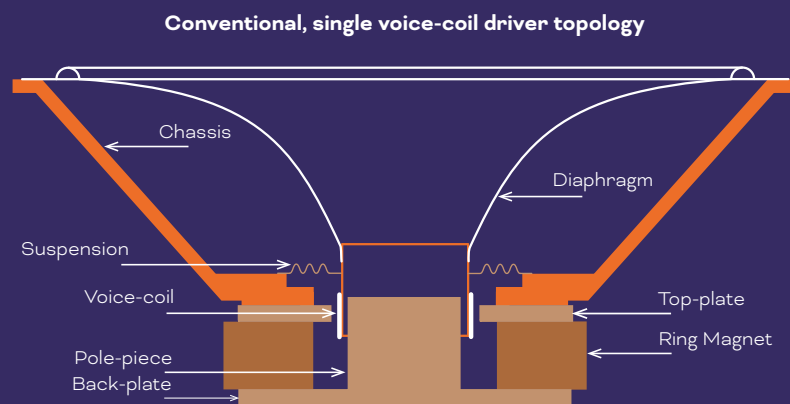

Furthermore, the effect of power compression, where speakers compress music as heat dissipated in the voice-coils raises their electrical resistance, is significantly mitigated by the presence of a second voice-coil. Mitigate power compression and the improvement in dynamic accuracy brings huge subjective benefits.

While the DALI KORE midrange driver diaphragm isn't required to move to anywhere near the same extent as the bass driver diaphragms, the reduction in odd-order harmonic distortion from a Balanced Drive arrangement is still significant - and at least as important. In fact, in combination with the Gen-2 iteration of our SMC technology, the distortion of the DALI KORE through the midrange is at a level that you would usually only be able to match in a laboratory setup with current driven drivers. The midrange driver implementation of patented Balanced Drive SMC also results in very high midrange sensitivity. At 93 dB, the driver is driven effortlessly, which helps to further reduce distortion and minimise power compression.

Voice-Coil Inductance Linearisation and Stabilisation

In combination with Balanced Drive and SMC, the DALI KORE bass and midrange drivers also incorporate shorting rings designed to inhibit the variation of the voice-coil's inductance as it moves. With shorting rings, voice-coil inductance that would otherwise increase with inward movement and decrease with outward movement, resulting in signal modulation of the crossover performance, remains linear.

“With twin voice-coils, nonlinearity is cancelled out by the complementary geometry of the pair.”

CLAUS FUTTRUP
DALI ACOUSTICS MANAGER

Balanced Drive SMC Bass Driver Motor System

The three curves below illustrate some of the benefits of DALI patented Balanced Driver SMC bass driver technology.

BL(x) Force Factor

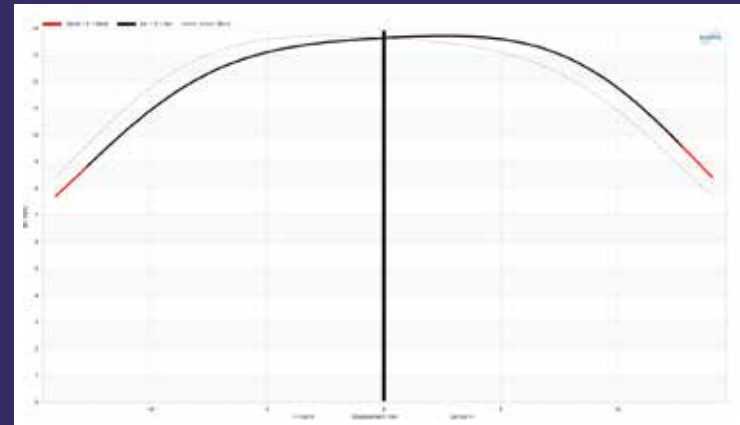

BL curve illustrates the linearity of the force imparted by the voice-coil on the diaphragm over an extremely wide range of voice-coil excursion.

Le(x) Inductance vs. excursion

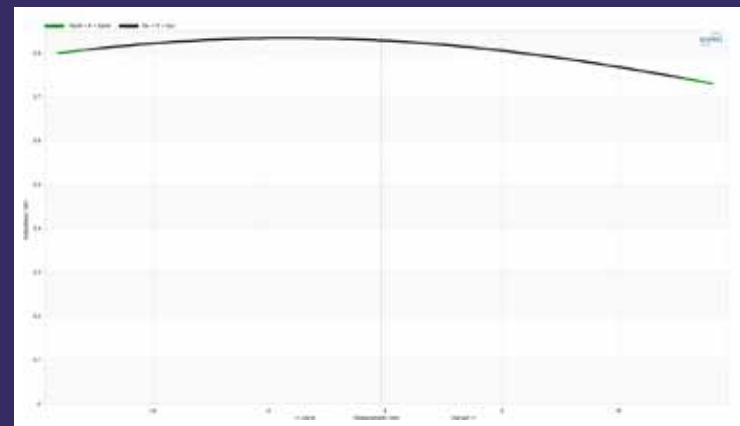

Inductance curve illustrates the minimal change in voice-coil inductance as the drive level increases.

Kms(x) Stiffness of Suspension

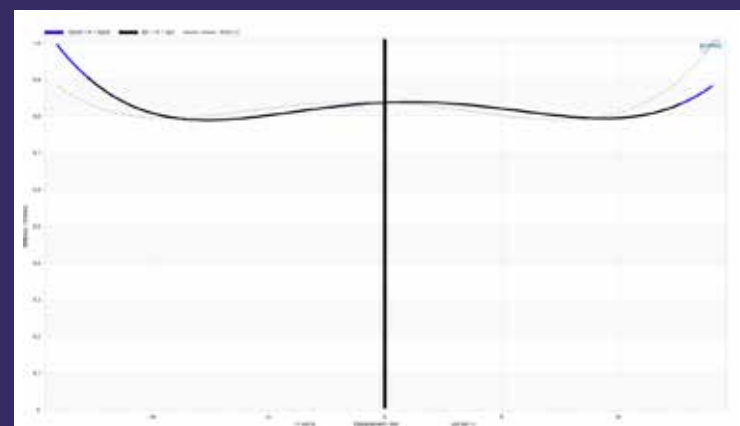

The suspension stiffness curve shows the bass driver's great suspension linearity over a very wide range of diaphragm travel.

DALI SMC

DALI SMC (Soft Magnetic Compound) is a coated granular material that offers the highly unusual combination of very high magnetic permeability and very low electrical conductivity. Being a granular compound, SMC can be moulded to shape as required, and although it is highly magnetically permeable (it can carry magnetic flux), its electrical conductivity is extremely low – approximately 1/10,000th of iron. SMC was developed by DALI in cooperation with a Danish specialist materials producer from outside the audio sector. The development of SMC uniquely provides an effective solution for some of the fundamental distortion and signal loss mechanisms of moving-coil drivers.

Hysteresis

Hysteresis describes the effects of magnetisation and de-magnetisation in response to an alternating input signal.

When iron-based magnet components are used in speaker motor systems – typically in the magnet system's top-plate and pole-piece – hysteresis is difficult to avoid. You'll see similar effects of hysteresis on a kitchen induction hob, which produces heat by using an alternating electrical field to transfer energy into the electrically and magnetically conductive iron of the pots and pans.

Although hysteresis may be useful in a kitchen environment, in a speaker the same effect means that iron close to the voice-coil is exposed to an alternating magnetic field from current in the voice-coil. When this happens, some of the energy provided by the amplifier is transformed into heat rather than music. With SMC's ultra low hysteresis losses and an electrical conductivity that's a fraction of iron, the unwanted generation of heat due to hysteresis is eliminated.

The result is extremely low distortion.

Frequency Linearity

In practice, magnetically conductive material inside, or close to, the voice coil will influence its self inductance. Although this happens no matter if iron or SMC is used, the transparency to the flux lines is very different between iron and SMC. Unlike iron, SMC behaves uniformly regardless of frequency, which greatly lowers distortion in the magnet system.

In a loudspeaker where the same current is running through the voice-coil and filter components, the properties of SMC means the self-inductance of the voice-coil is unchanged with frequency. This helps the crossover to operate freely across the entire frequency range.

Gen-2 SMC

The Gen-2 version of SMC introduced in the DALI KORE bass and midrange drivers offers significantly enhanced characteristics, especially at magnet flux densities above 1 Tesla, frequencies above 400 Hz, and with pole-pieces of more than 200 mm²: specifications all met in the DALI KORE bass and midrange drivers. At around 1/25,000th of the electrical conductivity of iron, Gen-2 SMC is 2.5 times less conductive than our first-generation SMC. The result is a further significant reduction in hysteresis, flux modulation and eddy currents, which translates to even lower loss and distortion.

SMC begins life as a granular material before being moulded into the required form. >



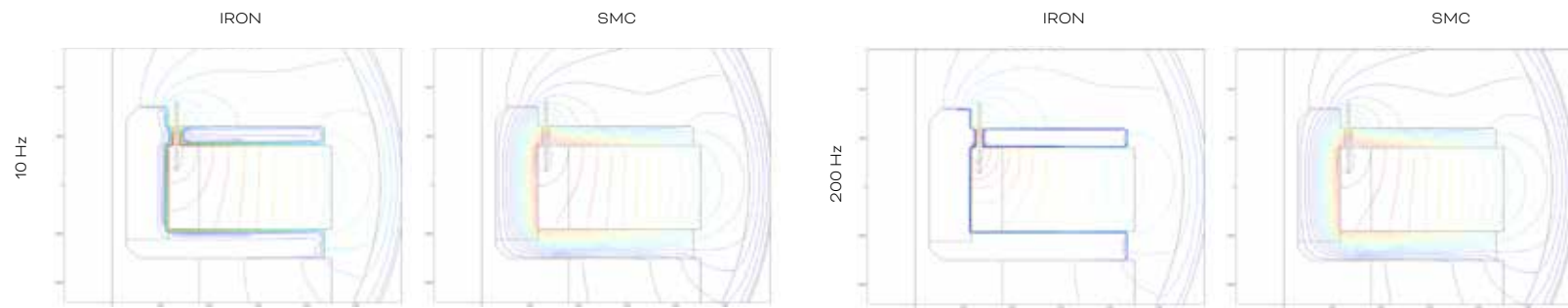

^ **Balanced Drive SMC Motor System Flux Lines**

These section views of a typical driver magnet system illustrate the increase in magnetic flux density and linearity at 10 Hz and 200 Hz resulting from the use of SMC material in comparison to a traditional iron based material. By using SMC instead of iron, the flux density and linearity doesn't change with frequency, which greatly reduces odd-order harmonics in the driver.

The SMC version is also significantly less influenced by the current in the voice-coil, which reduces the distortion from current generated flux variations.

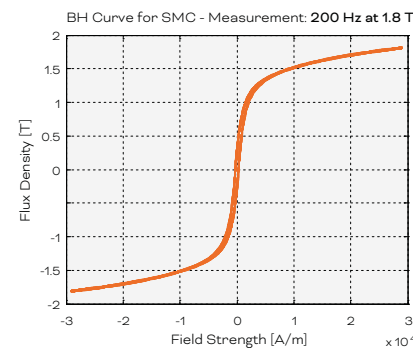
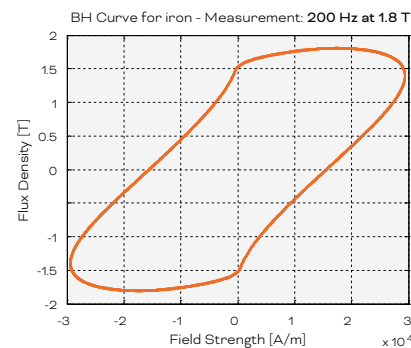
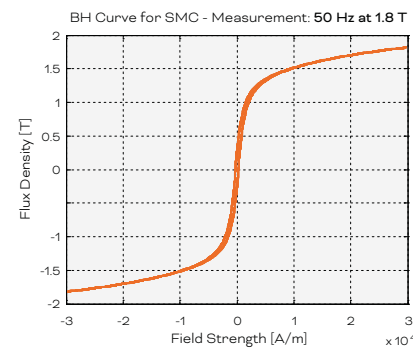
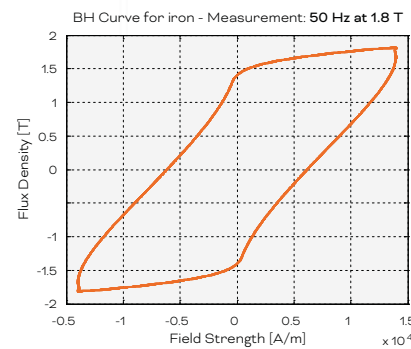
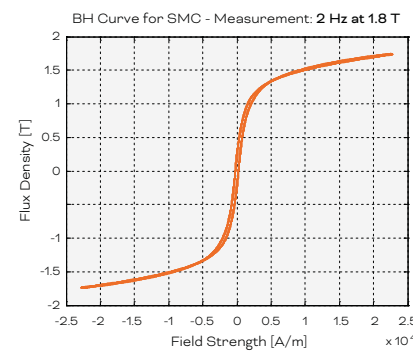
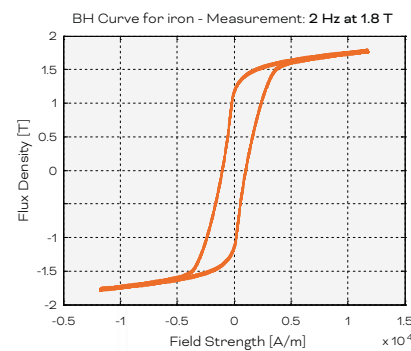

< **Hysteresis**

Hysteresis is a characteristic displayed by many materials that results in variation of behaviour with the reverse direction of an action. An example might be a spring that is stiffer in compression than extension. In some magnetic materials, hysteresis leads to differences in magnetisation and de-magnetisation characteristics. In conventional iron based speaker magnet systems, this causes significant distortion. In motor systems incorporating strategically located SMC elements, however, hysteresis is almost completely eradicated. The illustrations to the left compare the hysteresis magnetisation curves of conventional and SMC-equipped magnet systems at different frequencies.



Bass Drivers and Low Frequency System

The DALI KORE low frequency system comprises two port-loaded, 72 litre enclosures, each incorporating an 11½ inch driver fitted with a DALI patented Balanced Drive SMC twin 60.7 mm diameter voice-coil and twin suspension motor system.

Bass Driver Diaphragms

In addition to the Balanced Drive SMC motor system, the DALI KORE bass driver features a honeycomb sandwich paper-pulp diaphragm reinforced with wood fibres. The result is a stiff yet light component with just the right amount of inherent damping that's able to respond instantly and accurately to transient signals while maintaining its rigidity. The driver is terminated by a lightweight 50 Shore natural rubber roll-surround with properties specifically chosen to minimise the effects of nonlinear damping and hysteresis.

Differentially Filtered Bass Drivers

The twin bass drivers of the DALI KORE are located on the front panel approximately 85 cm apart. This spacing provides an opportunity to steer their vertical dispersion using differential filtering to optimise the radiation profile to the listening position.

The upper driver is filtered at a slightly lower frequency than the lower driver, producing a small phase difference between them that tilts the upper bass acoustic radiation away from the listening room floor towards comfortable listening positions.

Optimised Reflex Loading

The final element of the DALI KORE low frequency system is its reflex loading system. Reflex loading balances a speaker's low frequency bandwidth with its efficiency, power handling and time-domain performance. Achieving the right result ensures that the subjective bass performance of the speaker is musically accurate and satisfying, while ensuring bass diaphragm displacement and signal compression at high volumes are minimised. To achieve this level of performance, reflex ports must be engineered to minimise airflow turbulence and pipe resonances. For the DALI KORE, even though getting this right became more challenging as our aspirations for the speaker grew, we believe the results speak for themselves.



The twin DALI KORE reflex ports comprise one-piece moulded tubes of 80 mm internal diameter. Generous entrance and exit flaring of the port tubes ensures that airflow turbulence is minimised, while the port tube length is tuned to the perfect frequency. For the DALI KORE, we chose a very low port tuning frequency to ensure low-frequency musical elements are reproduced with absolute accuracy. This is critical, as it minimises imperfections in bass pitch, dynamics and timing, which are vital to the fundamental fidelity of music reproduction.

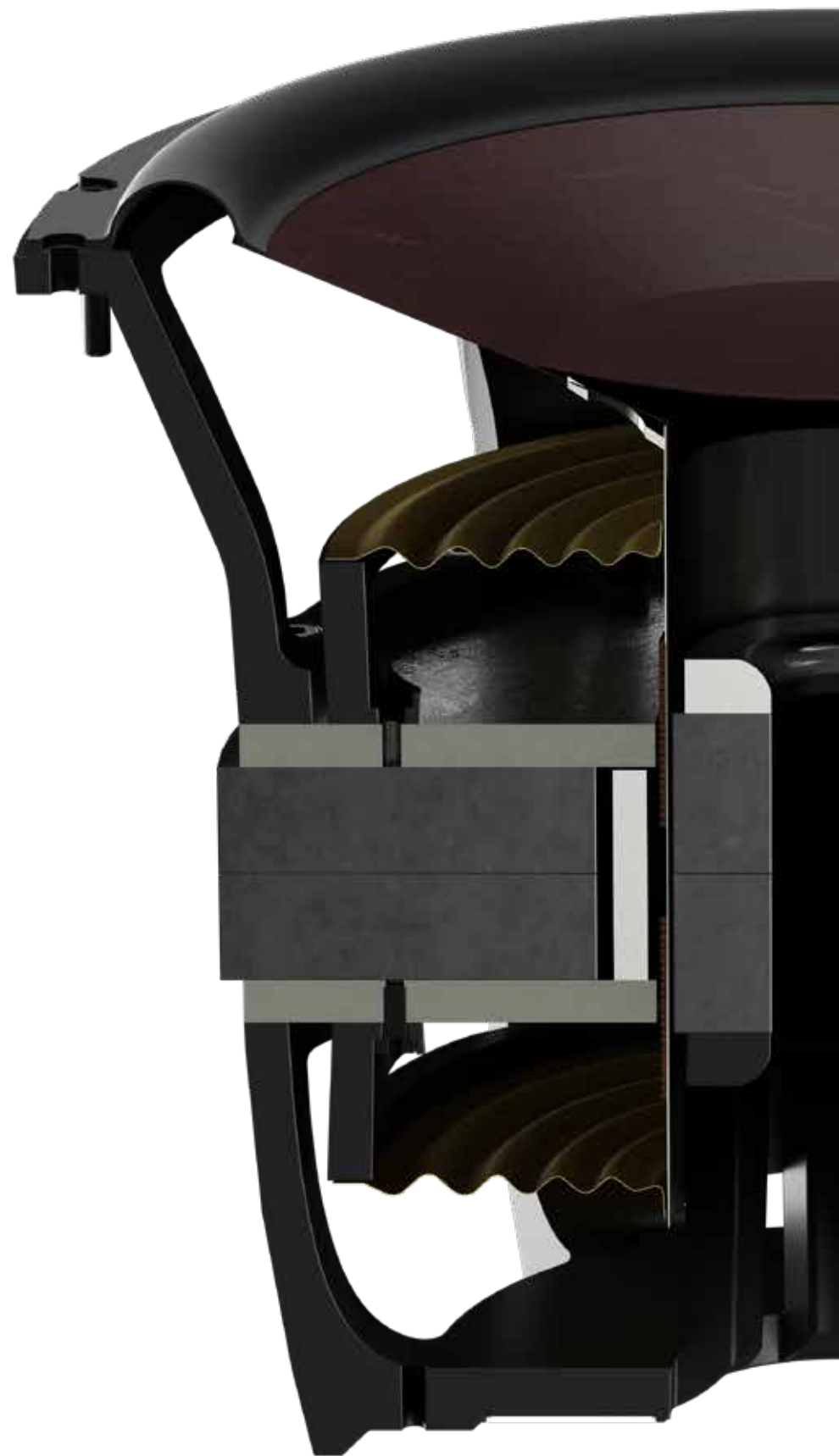

“ While bass creates the foundation of music, the midrange is where its soul lives and where much of the emotion it embodies is communicated. Melodies mostly make their living in the midrange too.”

LARS WORRE
DALI CHIEF EXECUTIVE OFFICER



“If you aspire to make the best speakers, the midrange should be your priority. And the wider you can make the midrange, the better your speaker will be.”

LARS WORRE
DALI CHIEF EXECUTIVE OFFICER



“Too much damping in a speaker is like too much cream in a sauce. It smooths everything out and makes things more palatable, but it suppresses the complexity of flavours too.”

LARS WORRE
DALI CHIEF EXECUTIVE OFFICER

Midrange Driver

It's no coincidence that human ears evolved to be most sensitive to midrange frequencies, from around 300 Hz to 3 kHz, as that's where vocal communication resides. It's also no coincidence that the midrange driver in a three or four-way speaker is typically responsible for reproducing a similar frequency range. It follows, then, that the quality, performance and subjective character of a midrange driver is of critical significance in a speaker such as the DALI KORE, which aspires to the highest possible performance and musical communication. For DALI, the DALI KORE marks our very first dedicated midrange driver – and it's a remarkable debut.

The DALI KORE Balanced Drive SMC midrange driver incorporates a lightweight, paper-pulp diaphragm, rigid vented titanium voice-coil former, and a suspension system specifically engineered to minimise nonlinear damping that causes loss of response speed and subjective detail.

The driver's relatively small rubber roll-surround is one example of this approach. As a midrange driver diaphragm doesn't need to travel as far as a bass driver, a smaller surround roll geometry is used.

Using a narrow surround shifts unwanted sound pressure generated by the surround when it goes out of phase with the diaphragm to higher frequencies. Shifting unwanted frequencies away from the diaphragm's working range, as well as reducing the sound pressure level of the surround, results in lower overall distortion of the midrange driver. The reduction of the moving mass of the rubber surround improves efficiency and lowers the hysteresis effects that are characteristic to some rubber based materials. By using low-loss material and the low mass of the surround, distortion is minimised.

This allows the midrange diaphragm to respond more quickly and with greater freedom for improved musical fidelity.

The DALI KORE midrange driver also features a newly developed paper and wood fibre diaphragm with a complex embossed geometric structure. The new diaphragm naturally displays all the benefits of the wood fibre technology well known from previous DALI designs: Wood fibres add stiffness and help promote non-resonant break-up characteristics. Wood fibre technology has proven to be significant in the reproduction of the finest musical details and dynamics.



“ One of the great advantages of a speaker that incorporates a dedicated bass driver is that its midrange driver, in not having to play bass, can be optimised for midrange frequencies. Rarely has this been more the case than with the DALI KORE.”

CLAUS FUTTRUP
HEAD OF ACOUSTIC ENGINEERING

The DALI KORE midrange diaphragm extends wood fibre technology by incorporating a new physical structure that helps to further linearise response behaviour towards the upper end of the midrange bandwidth. The diaphragm is embossed with a pattern of lines and then carefully hand coated. The coat thickens in the embossed lines which helps control the diaphragm modes. This technique enables local variation of the stiffness-to-damping ratio across the diaphragm and enables ultra-fine tuning of diaphragm performance and subjective character.

As with the DALI KORE bass drivers, the midrange driver is loaded by its own isolated enclosure volume. But in this case, the enclosure includes a varying cross-sectional area transmission line that progressively absorbs the rear radiation of the diaphragm. The enclosure is left open at its exit to avoid constraining the diaphragm's ability to accelerate or increase its fundamental resonance due to additional air stiffness.

The DALI KORE Midrange Development Story

The story of the DALI KORE midrange driver's long development is illustrative of the development of the DALI KORE as a whole. Though the initial configuration of the midrange driver met the objective design goals, its subjective performance wasn't quite in step with the character of the other elements. We therefore began a development

programme to investigate the roots of our subjective dissatisfaction and to find solutions. The DALI KORE team carried out numerous similar studies during the development.

Music is a fast-moving, dynamic narrative, yet much electro-acoustic analysis takes place under steady-state simulation. As is often the case when unexpected subjective performance flaws are identified in a speaker, the first place to look for clues is in its dynamic behaviour. Following painstaking analysis of the midrange driver's dynamic signature, the team discovered that, under certain conditions, the combination of the suspension design and the way the voice-coil was vented could result in air compression damping. At specific frequencies and voice-coil excursions, air could become trapped under the dust cap, which resulted in a transient distortion effect. Engineering the revised DALI KORE midrange driver required multiple suspension system iterations, as well as revising the voice-coil former ventilation holes, and modifying the stiffness and internal damping of the diaphragm. After making these modifications, the DALI KORE midrange driver addressed the subjective flaws bringing natural warmth and musical coherence to the abundant detail that was present from the start.

“ If you go for a hike in the country with a pair of binoculars, you’ll see every last detail of the landscape, but you’ll risk not seeing the big picture of its beauty. Designing a high-performance speaker carries the same risk. You can get too focused on the details of acoustic performance and forget that reproduced music only satisfies when whole, with all its character intact.”

LARS WORRE
DALI CHIEF EXECUTIVE OFFICER

Balanced Drive SMC Midrange Driver Frequency Response

The midrange driver frequency response chart below illustrates diaphragm behaviour with and without lacquer coating. The more linear response shape of the red curve illustrates the benefits of lacquer coating.

DALI KORE midrange before and after coating

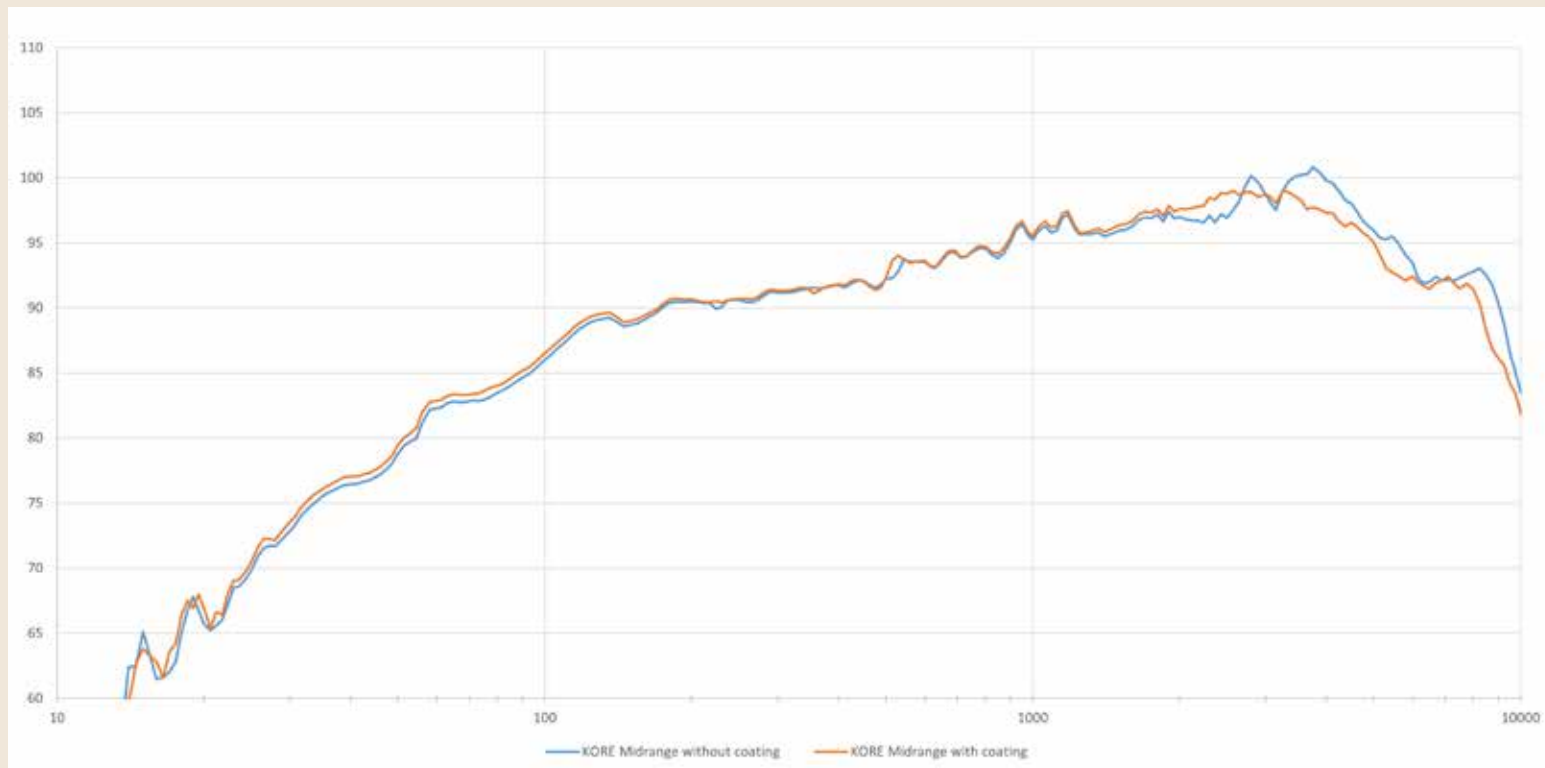

The ribbon element of the DALI KORE EVO-K Hybrid Tweeter is an enhanced version of the DALI EPICON series driver. With a wide bandwidth and wide horizontal high-frequency dispersion, the ribbon element dovetails perfectly with the dome tweeter's natural tendency to become more directional towards the top end of its range. Gently rolled in above 10 kHz, the ribbon element makes a full contribution from around 15 kHz to well above 30 kHz. Improvements over our previous hybrid tweeter

ribbon element include a much more powerful, premium-grade Neodymium-Iron-Boron system. The revised ribbon element also incorporates a new rear-mounted aluminium heatsink and re-profiled waveguide, engineered to optimise dispersion and integration with the hybrid driver's 35 mm dome tweeter. The new motor system, along with the re-profiled waveguide, results in an 8 dB increase in driver sensitivity and reduces both distortion and power compression.



“**Designing passive crossovers is very much like practicing an art, and the DALI KORE crossover is our masterpiece.**”

JACOB ERIKSEN
DALI ACOUSTIC ENGINEER



Passive Crossover

Passive crossovers are both simple and complex.

They don't merely integrate the drivers but fundamentally influence the response, dispersion, detail, colouration and tonal balance of a speaker. Their design is as much an art as it is a science.

While the theories of electrical filter design are well established, passive filters positioned after the power amplifier stage, feed drivers which often vary in input impedance with both frequency and volume level – which adds immense complexity.

The five-driver DALI KORE, with its individually filtered woofers, adds even more complexity. Although computer-aided modelling helped during the crossover design process, creating the finished product required near boundless imagination, intuition, experience and perseverance from the team.

The DALI KORE crossover is split across two circuit board assemblies – one located in the composite plinth and the other within the midrange and tweeter housing. Separating the crossover minimises the possibility of 'crosstalk' and facilitates bi-wiring/ bi-amping.

The plinth crossover assembly houses the components for the bass driver low pass filter as well as the low and high pass filter for the midrange, while the hybrid tweeter filter components are located inside the tweeter/midrange baffle assembly, with a very short signal path to the drivers.

Rather than conforming to any specific filter profile or topology, the DALI KORE crossover filters are designed to achieve specific acoustic frequency and phase response targets. This 'target function' approach to crossover design, which we have long practised at DALI, prioritises total system response and subjective musical performance equally.



Every DALI KORE development decision that could influence performance was made by listening.

Crossovers are not simply about filter design and driver integration. Their idiosyncrasies and complexities also make component choice vitally important. For the DALI KORE, every crossover component was selected based on subjective audio quality, rather than cost or physical size.

In the majority of cases, the crossover components that offered the lowest loss or distortion offered the best subjective performance.

When it came to capacitors, we opted for ultra-low-loss, metallised polypropylene.

Introducing SMC-KORE Inductors

With our choice of inductors we are introducing a new and “world’s first” component to the loudspeaker industry. For the DALI KORE, air-core inductors are used in combination with newly developed SMC-KORE inductors built on SMC Gen-2 cores. Compared to standard air-core inductors (especially at high inductances), this

technology allows lower DC resistance, shorter signal path and less vulnerability to crosstalk between inductors, while the properties of SMC Gen-2 offers excellent, ultra-low-loss filter components.

Each crossover component is located and mounted to minimise the risk of both microphony and crosstalk with nearby components.

When it came to the DALI KORE connection terminals, none of the commercially available components met our aspirations – so we decided to produce our own. The result is a unique connection terminal, custom designed, precision machined and gold plated to produce negligible contact resistance with a fine satin surface finish and a smooth, strong and highly dependable action. The connection terminal is effectively lossless and transparent to audio signals. It incorporates oversize thumbscrews for better grip on bare wires or spade terminals, and a self locking mechanism to ensure consistent and reliable connection when using banana plugs.

DALI KORE

Electro-Acoustic Specifications

The subjective performance of any Hi-Fi speaker is of course the final arbiter of its success. Some electro-acoustic measurements, however, can be correlated with subjective performance or define fundamental performance limits. Distortion, for example, falls into the first category, while maximum volume level falls into the second.

The following DALI KORE specifications can therefore never tell the whole story – only your ears and your favourite music can do that – but they do give you a sense of the truly exceptional electro-acoustic engineering achievement that is the DALI KORE.

DALI KORE Specifications

Frequency Range (+/- 3 dB)	26 Hz – 34 kHz
Sensitivity	89 dB @ 2.83 volts
Nominal Impedance	4 ohms
Minimum Impedance	3.2 ohms @ 72 Hz
Recommended Amplifier Power	100 – 1,500 watts
Bass Drivers	2 x 11½ inch Balanced Drive SMC
Midrange Driver	7 inch Balanced Drive SMC
Hybrid High Frequency Driver	35 mm soft textile dome
Hybrid Super High Frequency Driver	10 x 55 mm ribbon
Crossover Frequencies (Hz)	390/2,100/12,000
Low Frequency Enclosure Type	2 x 72 litre reflex loaded
Reflex Tuning Frequency	22 Hz
Midrange Frequency Enclosure Type	Attenuated open back line
Enclosure Construction	Curved 28 mm birch laminate composite with aluminium die-cast, thermoset resin and cast composite structural elements.
Enclosure Finishes	Gloss Lacquer Ammara Ebony veneer with contrasting textured finishes.
Connections	Custom designed, machined and gold-plated terminals suitable for bare wires, spade terminals and 4 mm plugs. Bi-wire/Bi-amp capable.
Dimensions (H x W x D)	1,675 x 448 x 593 mm 66 x 17.6 x 23.3 inches
Weight	140 kg

This white paper is preliminary and is therefore subject to change without notice.

DALI KORE

The Sum of Its Parts

The DALI KORE is the result of tangible design, technology and engineering, yet its end product – the communication and enjoyment of music – is more unquantifiable. The remarkable achievement of the DALI KORE is to marry extremely high objective electro-acoustic performance with intense musical enjoyment – whatever the music and volume level. The DALI KORE can play quietly, with all the finesse, subtlety and engagement of the best compact speakers, yet it can also play with the same finesse, subtlety and engagement at genuine live-music volume levels. And it does all this with apparently unlimited bandwidth, no audible distortion or colouration, and without the slightest hint of power compression. The DALI KORE is a speaker for all music, all listeners and all occasions.

Every speaker that carries the DALI logo is an expression of our design and engineering values and ideals. The DALI KORE is no different, however it's more than just another speaker in the DALI range. It represents a landmark in our story, where everything we've learned over four decades has culminated, not simply to create the best speaker we can, but also to create something that can inform and play a role in everything we do in the future. But above all else, the DALI KORE is a clear demonstration that DALI, and Danish design, engineering and manufacturing, stands among the best the world has to offer.

The DALI KORE is an unashamedly ambitious high-end Hi-Fi speaker – the ultimate expression of our passion for music. If you're fortunate enough to be able to own it, we hope it will become the only speaker you will ever need.



“ We made the DALI KORE because we wanted to show what DALI, and Denmark, can do, and because for so many years we have been encouraged to do it by our music-loving customers.”

LARS WORRE
DALI CHIEF EXECUTIVE OFFICER

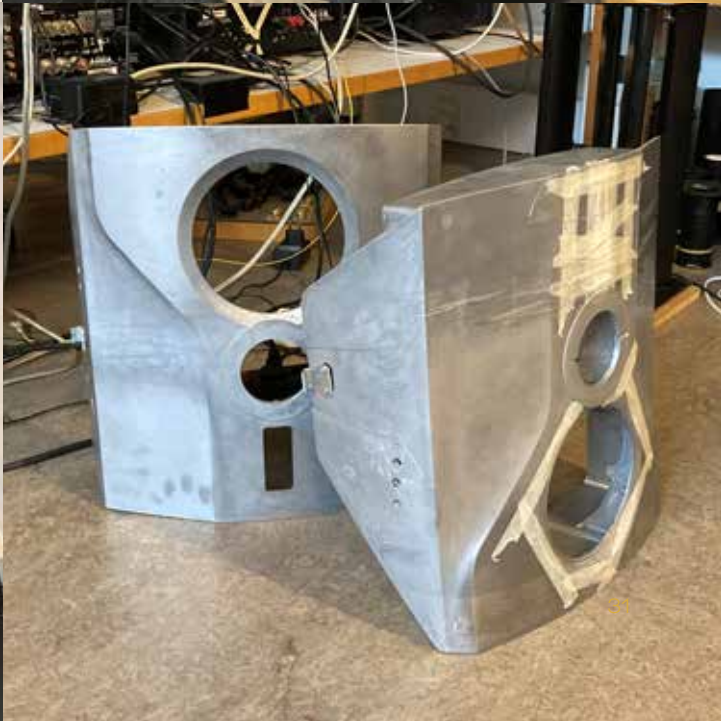



IN ADMIRATION OF MUSIC

www.dali-speakers.com